



PlaneSeries | Outline Seats and Benches



OS11x17 SS / Cedar



OB17 SS / Cedar



OS11x17

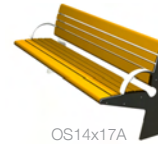

OS14x17A



OB17

Specification Options

Fabrication Material	<input type="checkbox"/> Steel	<input type="checkbox"/> Stainless Steel	<input type="checkbox"/> Aluminum
Powder Coat Colors	<input type="checkbox"/> Brown	<input type="checkbox"/> Green	<input type="checkbox"/> Charcoal
<input type="checkbox"/> Standard Gloss	<input type="checkbox"/> Standard Matte	<input type="checkbox"/> Clear Coat	<input type="checkbox"/> Custom Color
HDPE Colors	<input type="checkbox"/> Gray	<input type="checkbox"/> Cedar	<input type="checkbox"/> Weathered
<input type="checkbox"/> Custom			
Options	<input type="checkbox"/> 48" Seat	<input type="checkbox"/> 48" Bench	
<input type="checkbox"/> Arm	<input type="checkbox"/> Sleep Stopper	<input type="checkbox"/> 60" Seat	<input type="checkbox"/> 60" Bench
<input type="checkbox"/> Custom Length	<input type="checkbox"/> 72" Seat	<input type="checkbox"/> 72" Bench	
Installation Option	<input type="checkbox"/> Surface Mount	<input type="checkbox"/> Embedded	
Other Options	<input type="checkbox"/> Link Kit	<input type="checkbox"/> Mount Hardware Kit	



OB11

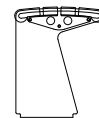

OB14

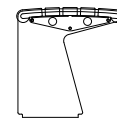

OB17

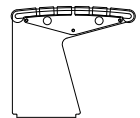

OB20

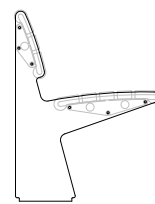

OS11x17

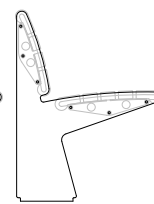

OS14x17

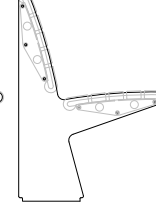

OS17x17

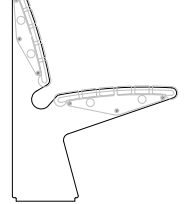

OS17x20-ADA

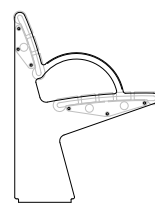

OS11x17A

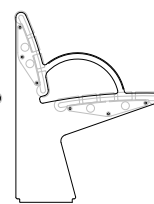

OS14x17A

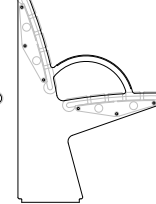

OS17x17A

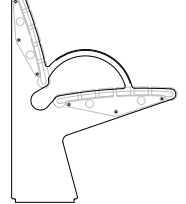

OS17x20A-ADA

** All Seat and back platforms are curved.



PlaneSeries | Cantilever Seats and Benches



OB17 SS / Cedar



OB17 SS / Cedar

Specification Options

Fabrication Material	<input type="checkbox"/> Steel	<input type="checkbox"/> Stainless Steel	<input type="checkbox"/> Aluminum
Powder Coat Colors	<input type="checkbox"/> Brown	<input type="checkbox"/> Green	<input type="checkbox"/> Charcoal
<input type="checkbox"/> Standard Gloss	<input type="checkbox"/> Black	<input type="checkbox"/> Red	
<input type="checkbox"/> Standard Matte			
<input type="checkbox"/> Clear Coat			
<input type="checkbox"/> Custom Color			
HDPE Colors	<input type="checkbox"/> Gray	<input type="checkbox"/> Cedar	<input type="checkbox"/> Weathered
<input type="checkbox"/> Custom			
Options	<input type="checkbox"/> 48" Seat	<input type="checkbox"/> 48" Bench	
<input type="checkbox"/> Arm	<input type="checkbox"/> Sleep Stopper	<input type="checkbox"/> 60" Seat	<input type="checkbox"/> 60" Bench
<input type="checkbox"/> Custom Length	<input type="checkbox"/> 72" Seat	<input type="checkbox"/> 72" Bench	
Installation Option	<input type="checkbox"/> Surface Mount	<input type="checkbox"/> Embedded	
Other Options	<input type="checkbox"/> Link Kit	<input type="checkbox"/> Mount Hardware Kit	

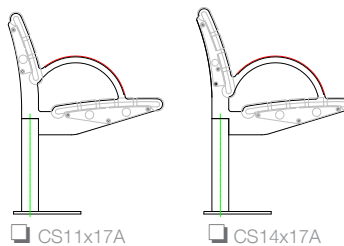
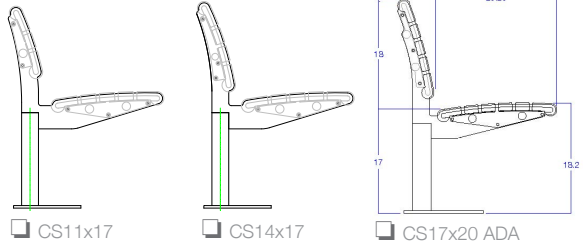

** All Seat and back platforms are curved.

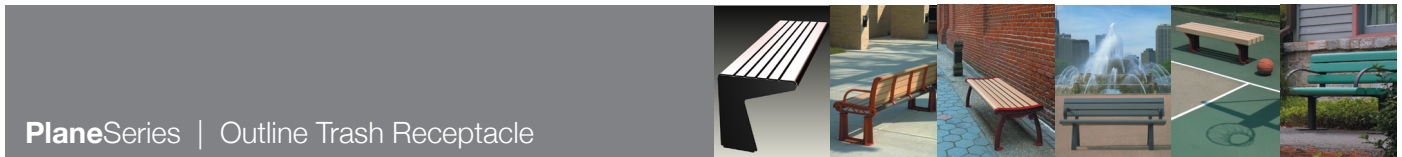

PlaneSeries | Outline Trash Receptacle

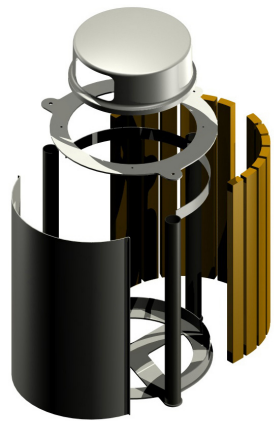

Trash Receptacle is shipped KD to be assembled on site. Door assembly is complete and top element is installed in top plate. Vertical tubes provide door pivot and basic structure. Slats are pre-drilled. Liner is required.



Side view showing slats

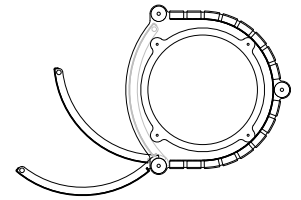

High Dome



Front view showing door

Specification Options

Fabrication	<input type="checkbox"/> Steel <input type="checkbox"/> Stainless Steel <input type="checkbox"/> Aluminum
Powder Coat Colors	<input type="checkbox"/> Brown <input type="checkbox"/> Green <input type="checkbox"/> Charcoal <input type="checkbox"/> Black <input type="checkbox"/> Red
HDPE Colors	<input type="checkbox"/> Gray <input type="checkbox"/> Cedar <input type="checkbox"/> Weathered
Capacity	<input type="checkbox"/> 32G
Plastic Liner	<input type="checkbox"/> 32G - 9809L (Liner)
Top Cover Option	<input type="checkbox"/> Plane/Dome <input type="checkbox"/> High Plane <input type="checkbox"/> Low Ring <input type="checkbox"/> High Dome
Installation Option	<input type="checkbox"/> Surface <input type="checkbox"/> Embedded

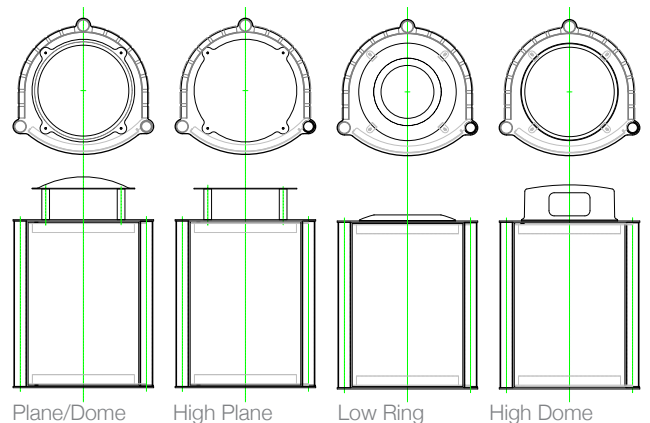

November 2011 v11.1 Fahnstrom/White Design



PlaneSeries | Outline Picnic Table ADA Universal



ADA Required accommodation dimensions are provided at both end locations for 60" and 72" tables.



Table shown is 72" with two OB11F Benches. (OB14F Benches are optional) Stainless Steel end panels with HDPE Cedar slats. The pre-assembled top bolts onto steel column. Sheet metal column screen.

Specification Options

Fabrication	<input type="checkbox"/> Steel <input type="checkbox"/> Stainless Steel <input type="checkbox"/> Aluminum
Powder Coat Colors	<input type="checkbox"/> Brown <input type="checkbox"/> Green <input type="checkbox"/> Charcoal <input type="checkbox"/> Black <input type="checkbox"/> Red
HDPE Colors	<input type="checkbox"/> Turf Green <input type="checkbox"/> Gray <input type="checkbox"/> Cedar <input type="checkbox"/> Weathered
Dimension	<input type="checkbox"/> 60" - ADA Universal <input type="checkbox"/> 72" - ADA Universal
Bench Option**	<input type="checkbox"/> OUT.BE.11.F - 60" / 72" <input type="checkbox"/> OUT.BE.14.F - 60" / 72"
Installation	<input type="checkbox"/> Surface Only

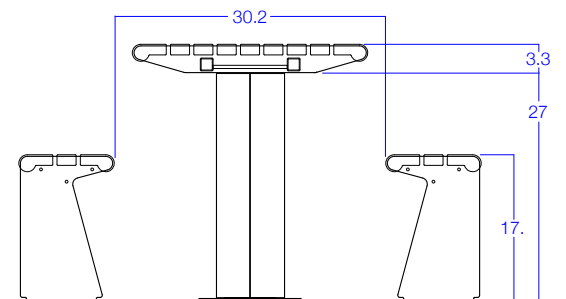
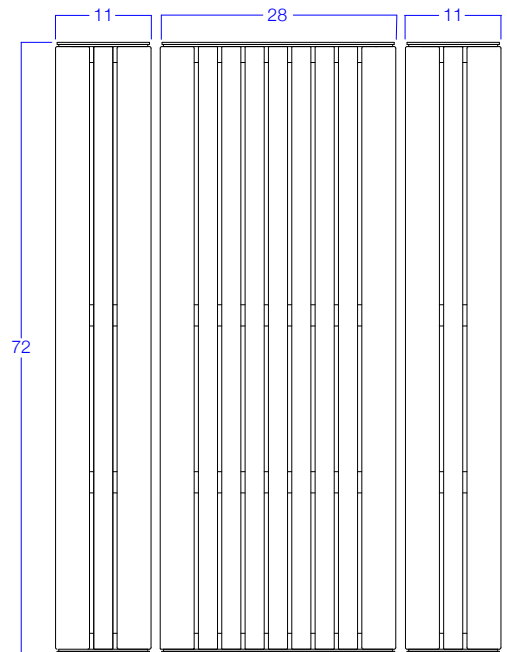

** Bench platforms specified for the picnic table are flat.

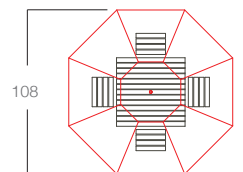
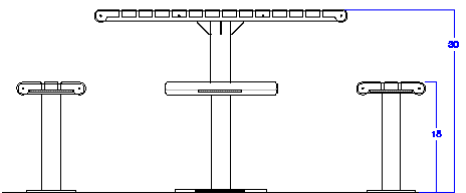
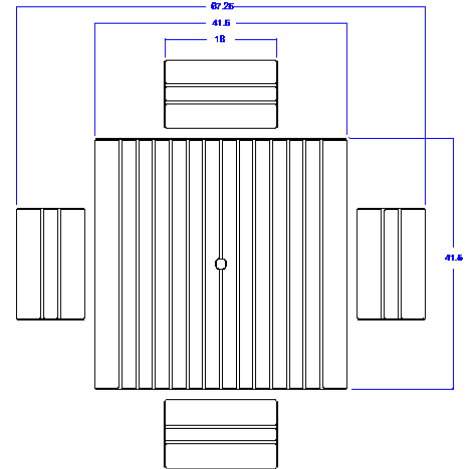
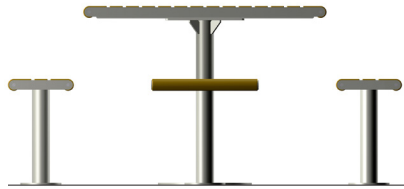

PS.PT.4141.SB.5T

W.INF.UMB.732

Umbrella Dimensions

Specification Options * Asterisk categories must be selected

- * **Powder Coat Color**
 - Custom Gloss/Specify
 - Custom Matte/Specify
 - Brown
 - Green
 - Charcoal
 - Black
- * **HDPE Plank Colors**
 - Custom/Specify
 - Gray
 - Cedar
 - Weathered
- * **Table Top 41x41_4T**
 - PS.PT.41X41.4T
 - Umbrella 108" Octagonal W.INF.UMB.732
 - Surface Mount Hardware 9300-004-INST

Key Features:

- Powder Coat Steel Frame
- HDPE Seat and Top Slats
- Seat/Top units ship assembled
- Seat assemblies bolt to frame
- Top assembly bolts to frame
- Table is surface mount only
- Table may be used unmounted
- Umbrella must be ordered separately
- Umbrella: W.INF.UMB.732

PatioCollection | 41X41_Patio Table 3T_ADA

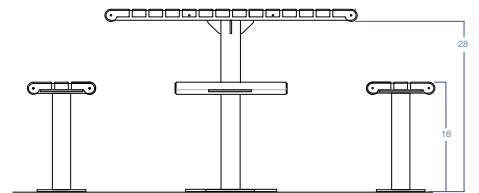
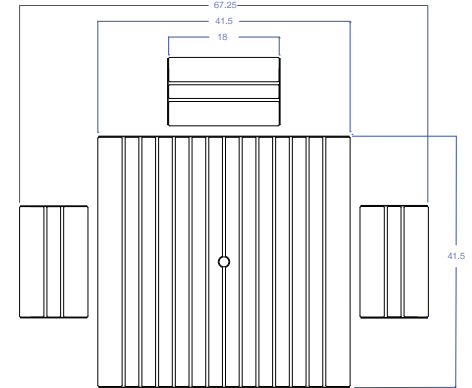
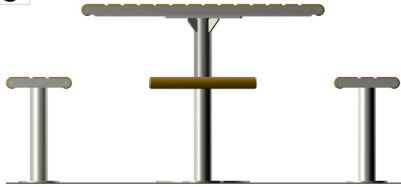

PS.PT.4141.3T.ADA

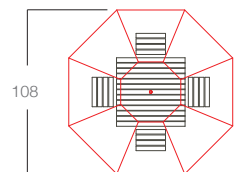

W.INF.UMB.732

Umbrella Dimensions

Specification Options * Asterisk categories must be selected

- | | |
|---|---|
| * Powder Coat Color | <input type="checkbox"/> Brown |
| <input type="checkbox"/> Custom Gloss/Specify | <input type="checkbox"/> Green |
| <input type="checkbox"/> Custom Matte/Specify | <input type="checkbox"/> Charcoal |
| | <input type="checkbox"/> Black |
| * HDPE Plank Colors | <input type="checkbox"/> Gray |
| <input type="checkbox"/> Custom/Specify | <input type="checkbox"/> Cedar |
| | <input type="checkbox"/> Weathered |
| * Table Top 41x41_3T.ADA | <input type="checkbox"/> PS.PT.41X41.3T.ADA |
| Umbrella 108" Octagonal | <input type="checkbox"/> W.INF.UMB.732 |
| Surface Mount Hardware | <input type="checkbox"/> 9300-004-INST |

Key Features:

- Powder Coat Steel Frame
- HDPE Seat and Top Slats
- Seat/Top units ship assembled
- Seat assemblies bolt to frame
- Top assembly bolts to frame
- Table is surface mount only
- Table may be used unmounted
- Umbrella must be ordered separately
- Umbrella: W.INF.UMB.732